

ARL-1210URC-270mcd (3528S35FC)

Features

- PLCC-2 Package
- Extremely wide viewing angle
- Suitable for all SMT assembly and solder process
- Available on tape and reel
- Moisture sensitivity level: Level 4
- Package:2000pcs/reel
- RoHS compliant

Description

The Red source color devices are made with AlGaInP on Substrate Light Emitting Diode

Applications

- Optical indicator
- Indoor display
- Backlighting in dashboard and switch
- Flat backlighting for LCD, symbol and display
- General use

Package Dimensions

- 1.All dimension units are millimeters.
- 2.All dimension tolerance is $\pm 0.15\text{mm}$ unless otherwise noted.

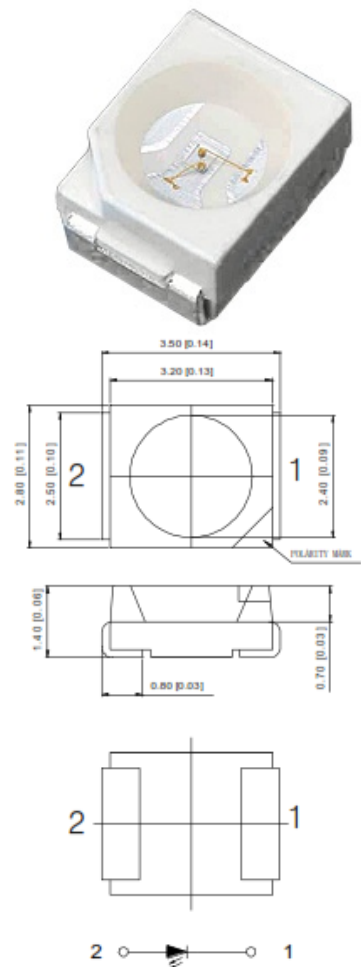

Part No.	Dice	Lens Type	Iv (mcd) @ 20mA		Viewing Angle
			Min.	Typ.	2θ1/2
ARL-1210URC-270mcd	RED(AlGaInP)	Water Clear	210	270	120°

Notes

1. $\theta_{1/2}$ is the angle from optical centerline where the luminous intensity is 1/2 the optical centerline value.
2. The above luminous intensity measurement allowance tolerance $\pm 10\%$.

Electrical / Optical Characteristics at TA=25°C

Symbol	Parameter	Min.	Typ.	Max.	Units	Test Conditions
VF	Forward Voltage	1.8	--	2.4	V	IF=20mA
IR	Reverse Current	--	--	10	uA	VR = 5V
λ_D	Dominant Wavelength	620	--	630	nm	IF=20mA

Absolute Maximum Rating

Parameter	Value	Units
Power dissipation	75	mW
DC Forward Current	30	mA
Peak Forward Current [1]	140	mA
Reverse Voltage	5	V
Electrostatic Discharge (HBM)	2000	V
Operating Temperature	-40~+85	°C
	-40~+100	°C

Note:

1. 1/10 Duty Cycle, 0.1ms Pulse Width
2. The above forward voltage measurement allowance tolerance $\pm 0.1\text{V}$

Reliability Test Items And Conditions

The reliability of products shall be satisfied with items listed below.

Confidence level :90% LTPD :10%

No.	Items	Ref. Standard	Test Condition	Test Hours/ Cycles	Sample Size	Ac/Rc
1	Reflow	JESD22-B106	Temp: 260°C max T=10 sec	3 Min.	22Pcs.	0/1
2	Temperature Cycle	JESD22-A104	H: + 100°C 30 min. ~ 5 min L: -40°C 30 min.	100 Cycles	22Pcs.	0/1
3	Thermal Shock	JESD22-A106	H: +100°C±5°C 5 min. ~ L:- 40°C±5°C5 min.	100 Cycles	22Pcs.	0/1
4	High Temperature Storage	JESD22-A103	Temp.: 100°C ±5°C	1000Hrs.	22Pcs.	0/1
5	Low Temperature Storage	JESD22-A119	Temp.: -40°C ±5°C	1000Hrs.	22Pcs.	0/1
6	DC Operating Life	JESD22-A108	Ta=25°C±5°C IF=20mA	1000Hrs.	22Pcs.	0/1
7	High Temperature/ High Humidity	JESD22-A101	85°C±5°C/R.H85% IF=5mA	1000Hrs.	22Pcs.	0/1

*The technical information shown in the data sheets are limited to the typical characteristics and circuit examples of the referenced products. It does not constitute the warranting of industrial property nor the granting of any license.

Ambient Temperature VS. Forward Current

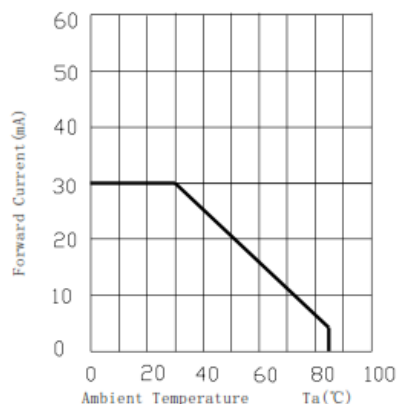

Forward Current VS. Relative Intensity

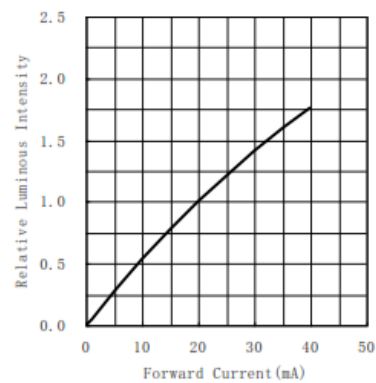

Forward Voltage VS. Forward Current

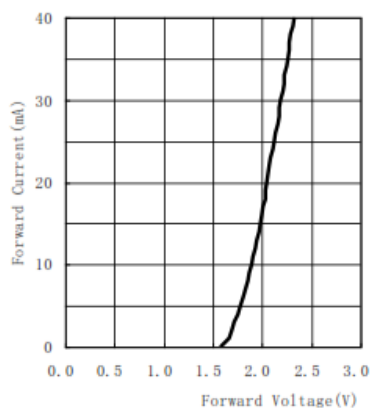

Ambient Temperature VS. Relative Intensity

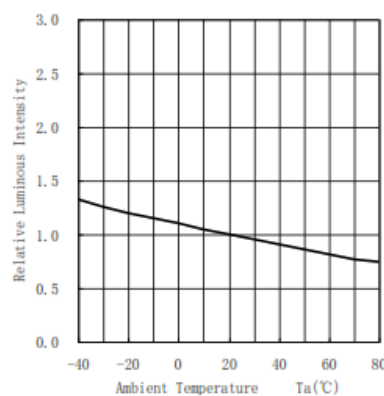

Relative spectral emission

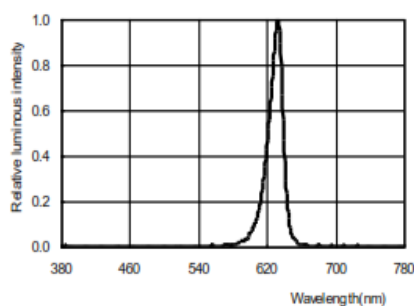
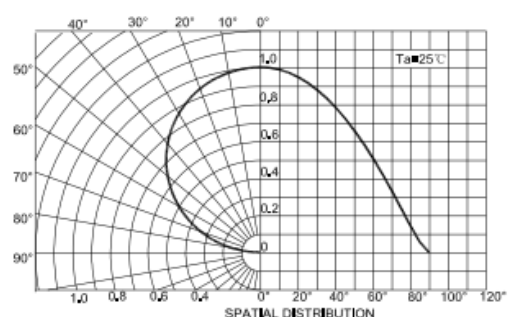
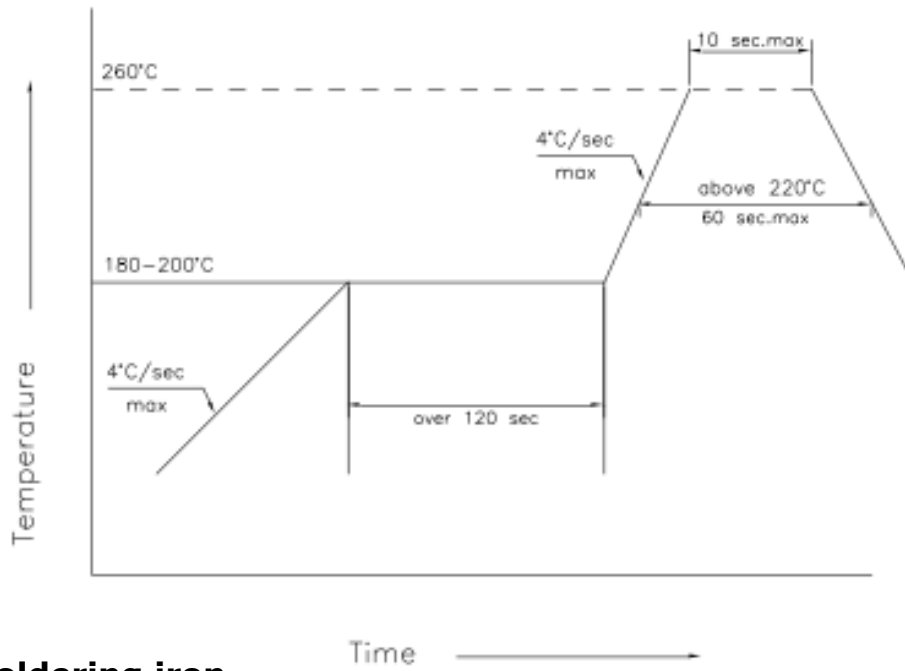

Diagram characteristics of radiation



SMT Reflow Soldering Instructions



1. Reflow soldering should not be done more than two times
2. When soldering, do not put stress on the LEDs during heating

Soldering iron

1. When hand soldering, the temperature of the iron must be less than 300°C for 3 seconds
2. The hand solder should be done only one time

Repairing

Repair should not be done after the LEDs have been soldered. When repairing is unavoidable, a double-head soldering iron should be used (as below figure). It should be confirmed beforehand whether the characteristics of LEDs will or will not be damaged by repairing.

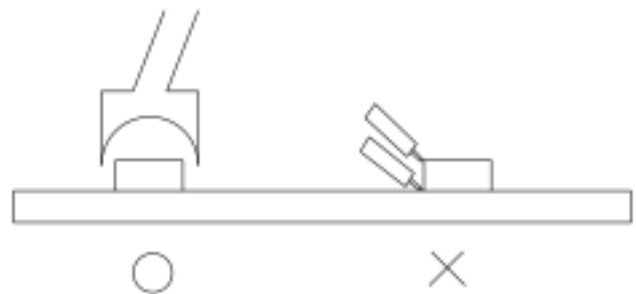

Tape Specifications

(Units : mm)

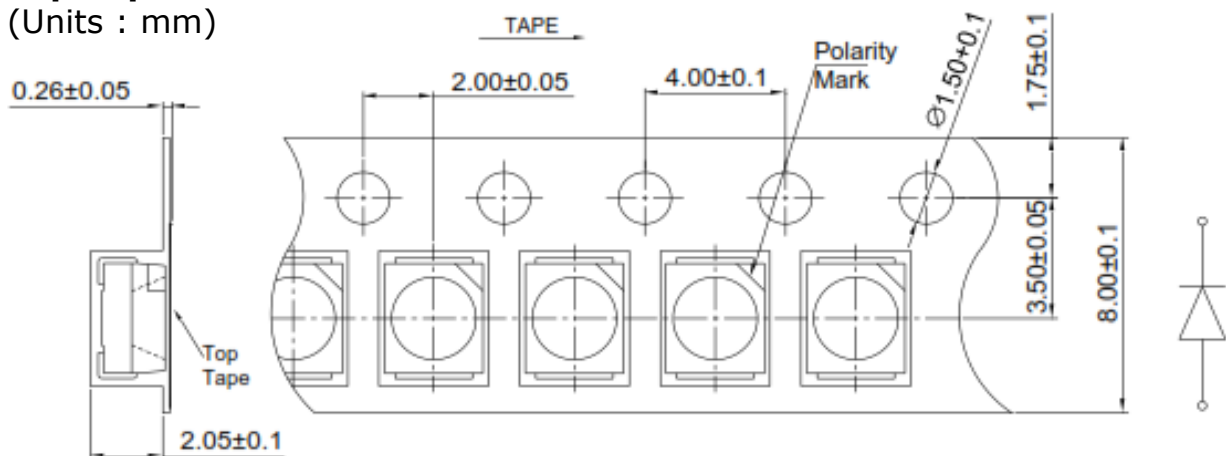

Moisture Resistant Packaging

Reel Dimensions

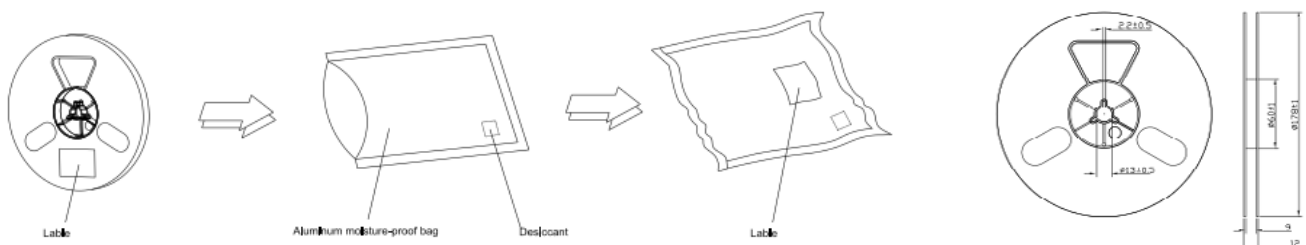

Handling Precautions

Compare to epoxy encapsulant that is hard and brittle, silicone is softer and flexible. Although its characteristic significantly reduces thermal stress, it is more susceptible to damage by external mechanical force. As a result, Special handling precautions need to be observed during assemble using silicone encapsulated LED products, Failure to comply might leads to damage and prema-

1.Handle the component along the side surface by using forceps or appropriate tools; do not directly touch or Handle the silicone lens surface, it may damage the internal circuitry.

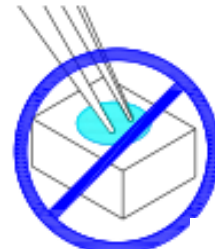
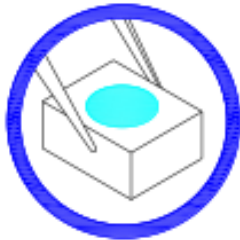

2.The outer diameter of the SMD pickup nozzle should not exceed the size of the LED to prevent air leaks. The inner diameter of the nozzle should be as large as possible. A pliable material is suggested for the nozzle tip to avoid scratching or damaging the LED surface during pickup. The dimensions of the component must be accurately programmed in the pick-and-place machine to insure precise pickup and avoid damage during production.



3.Do not stack together assembled PCBs containing LEDs. Impact may scratch the silicone lens or damage the internal circuitry

4.Not available in the situation of acidity for PH

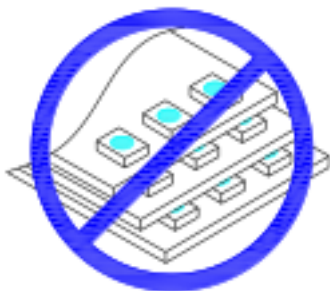

5.LED operating environment and sulfur element composition cannot be over 100PPM in the LED mating

6.When we need to use external glue for LED application products, please make sure that the external glue matches the LED packaging glue. Additionally ,as most of LED packaging glue is silica gel, and it has strong Oxygen permeability as well as strong moisture permeability; in order to prevent external material from getting into the inside of LED, which may cause the malfunction of LED, the single content of Bromine element is required to be less than 900PPM,the single content of Chlorine element is required to be less than 900PPM, the total content of Bromine element and Chlorine element in the external glue of the application products is required to be less than 1500PPM

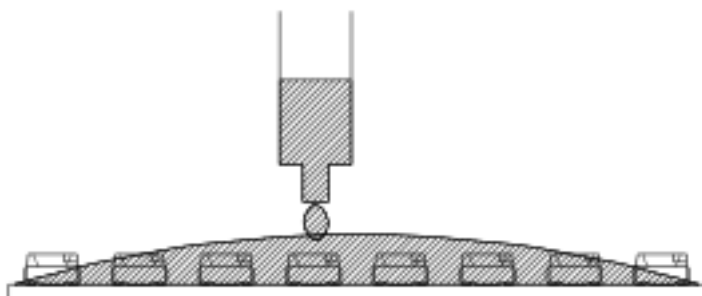

7.Other points for attention, please refer to our LED user manual.